

ACMS40N04V8-HF

**N-Channel
RoHS Device
Halogen Free**

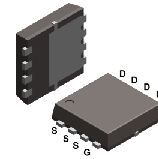

Features

- Super low gate charge.
- Green device available.
- Excellent C_{dv}/dt effect decline.
- Advanced high cell density trench technology.
- AEC-Q101 Qualified.

Mechanical data

- Case: PDFN3x3-8L, molded plastic.
- Molding compound: UL flammability classification rating 94V-0.
- Terminals: Matte tin plated leads, solderability per MIL-STD-202, method 208.

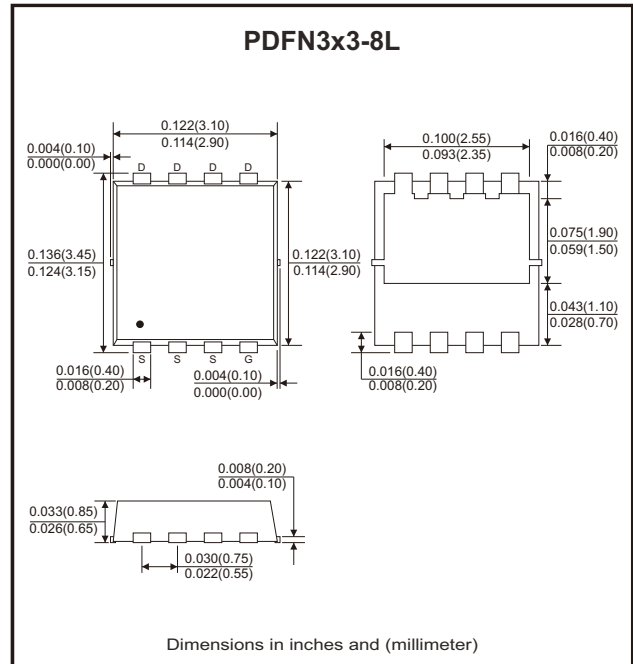

Circuit Diagram

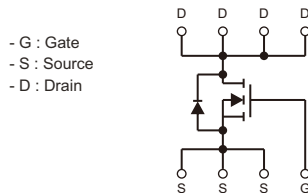

Maximum Ratings (at TA=25°C unless otherwise noted)

Parameter	Symbol	Value	Unit
Drain-source voltage	V_{DSS}	40	V
Gate-source voltage	V_{GSS}	±20	V
Continuous drain current (T _c =25°C) (Note 1)	I_D	40	A
Continuous drain current (T _c =100°C) (Note 1)	I_D	28	
Pulsed drain current (Note 2)	I_{DM}	120	A
Single pulse avalanche energy (Note 3)	E_{AS}	78	mJ
Power dissipation (T _c =25°C)	P_D	25	W
Thermal resistance junction to case (Note 1)	$R_{\theta JC}$	5	°C/W
Operating junction temperature range	T_J	-55 to +150	°C
Storage temperature range	T_{STG}	-55 to +150	°C

Electrical Characteristics (at T_A=25°C unless otherwise noted)

Parameter	Symbol	Conditions	Min	Typ	Max	Unit
Static Characteristics						
Drain-source breakdown voltage	V _{DSS}	V _{GS} = 0V, I _D = 250μA	40			V
Zero gate voltage drain current	I _{DSS}	V _{DS} = 32V, V _{GS} = 0V, T _C = 25°C			1	μA
Gate-body leakage current	I _{GSS}	V _{GS} = ±20V, V _{DS} = 0V			±100	nA
On Characteristics						
Static drain-source on-resistance (Note 2)	R _{DS(on)}	V _{GS} = 10V, I _D = 12A			8	mΩ
	R _{DS(on)}	V _{GS} = 4.5V, I _D = 10A			10	mΩ
Gate threshold voltage	V _{GS(th)}	V _{DS} = V _{GS} , I _D = 250μA	1.2		2.5	V
Dynamic Characteristics						
Input capacitance	C _{iss}	V _{GS} = 0V, V _{DS} = 15V, f = 1MHz		2332		pF
Output capacitance	C _{oss}			193		
Reverse transfer capacitance	C _{rss}			138		
Switching Characteristics						
Turn-on delay time	t _{d(on)}	V _{DD} = 15, V _{GS} = 10V R _G = 3.3Ω, I _D = 1A		14.3		ns
Turn-on rise time	t _r			2.6		
Turn-off delay time	t _{d(off)}			77		
Turn-off fall time	t _f			4.8		
Total gate charge	Q _g	V _{DD} = 20V, V _{GS} = 4.5V, I _D = 20A		18.8		nC
Gate to source charge	Q _{gs}			4.7		
Gate to drain (miller) charge	Q _{gd}			8.2		
Source-Drain Diode Characteristics						
Diode forward voltage (Note 2)	V _{SD}	I _{SD} = 1A, V _{GS} = 0V, T _J = 25°C			1.2	V
Drain continuous forward current (Note 1, 4)	I _S				70	A
Pulsed source drain current (Note 2, 4)	I _{SM}				50	A

Notes: 1. The data tested by surface mounted on 1 inch² FR-4 board with 2oz cooper.

2. The data tested by pulsed, pulse width ≤ 300μs, duty cycle ≤ 2%.

3. The EAS data shows Max. rating. The test condition is V_{DD}=25V, V_{GS}=10V, L=0.5mH.

4. The data is theoretically the same as I_D and I_{DM}, in real applications, should be limited by total power dissipation.

Rating and Characteristic Curves (ACMS40N04V8-HF)

Fig.1 - Typical Output Characteristics

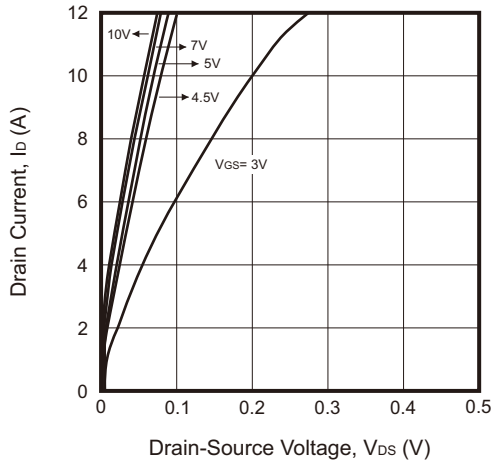

Fig.2 - Maximum Safe Operating Area

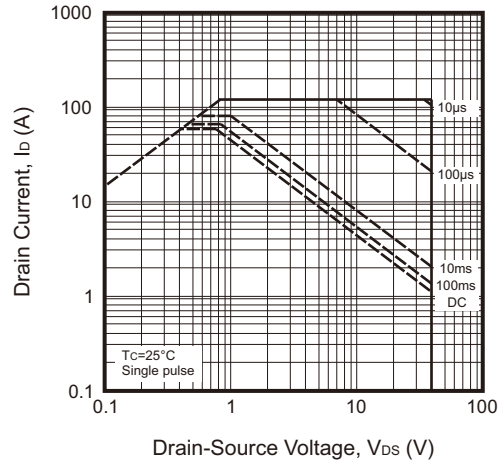

Fig.3 - On-Resistance vs. Gate-Source Voltage

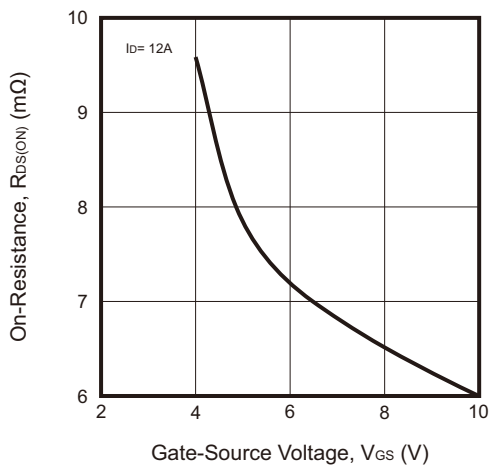

Fig.4 - Body-Diode Characteristics

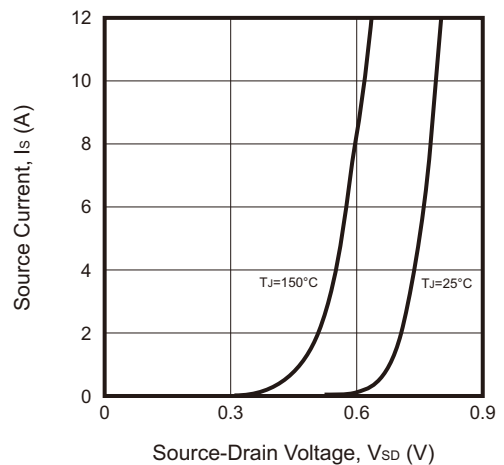

Fig.5 - On-Resistance vs. Junction Temperature

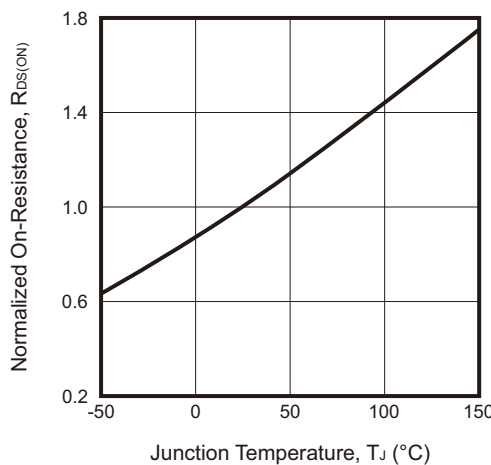
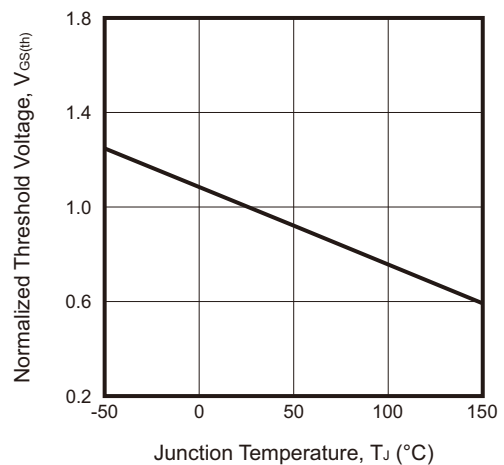

Fig.6 - $V_{GS(th)}$ vs. Junction Temperature



Rating and Characteristic Curves (ACMS40N04V8-HF)

Fig.7 - Capacitance Characteristics

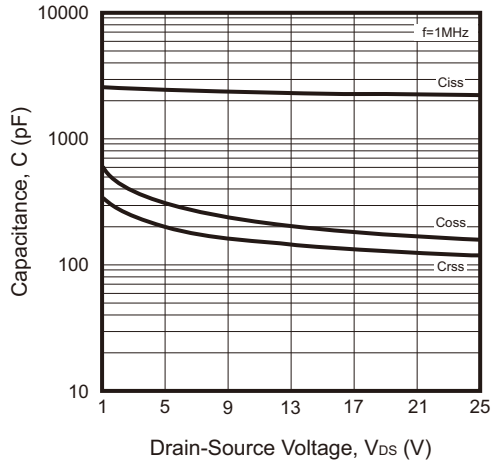
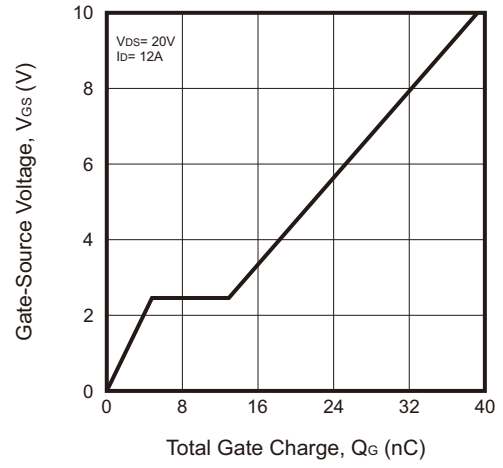
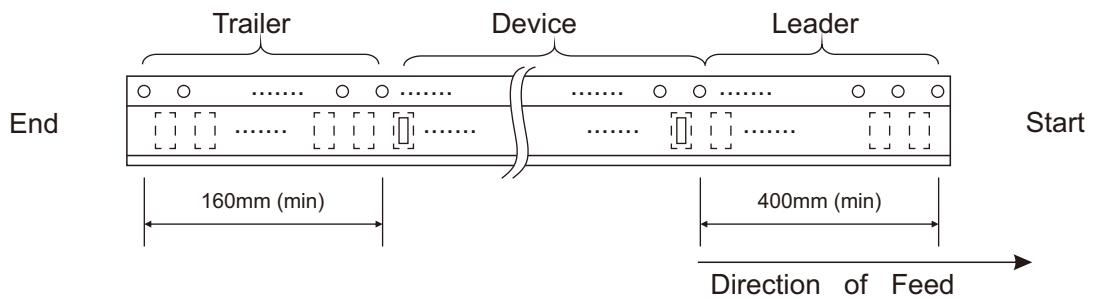
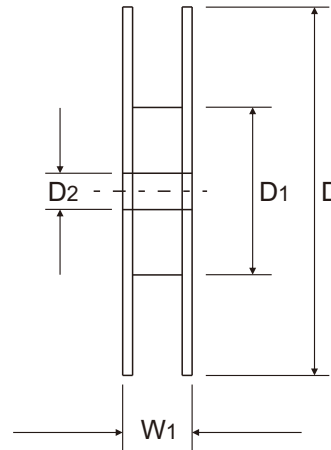
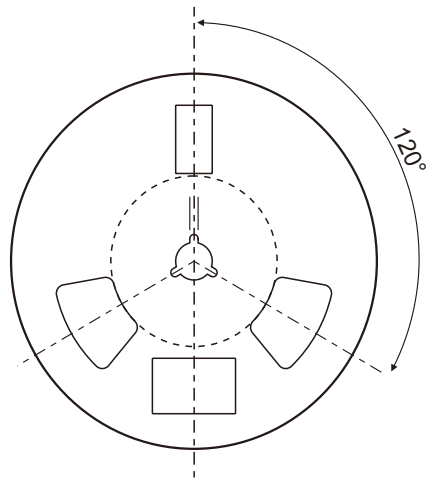
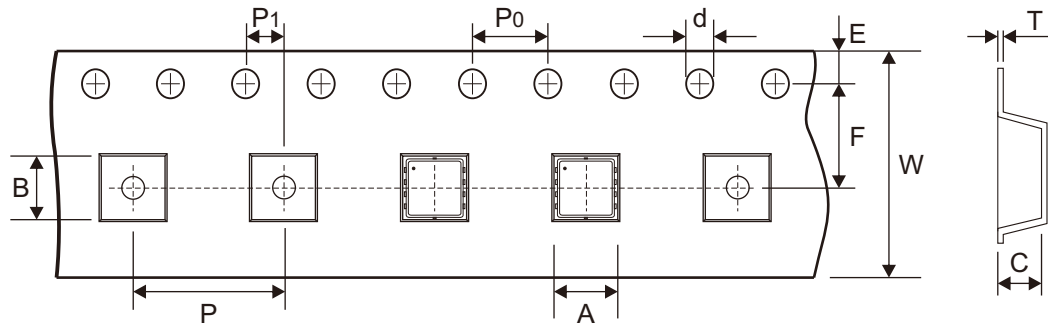

Fig.8 - Gate-Charge Characteristics



Reel Taping Specification



PDFN3x3 -8L	SYMBOL	A	B	C	d	D	D1	D2
	(mm)	3.60 ± 0.10	3.60 ± 0.10	1.20 ± 0.10	1.50 + 0.10 - 0.00	330 ± 1.00	100 ± 1.00	13.00 ± 0.20
	(inch)	0.142 ± 0.004	0.142 ± 0.004	0.047 ± 0.004	0.059 + 0.004 - 0.000	12.992 ± 0.039	3.937 ± 0.039	0.512 ± 0.008

PDFN3x3 -8L	SYMBOL	E	F	P	P0	P1	T	W	W1
	(mm)	1.75 ± 0.10	5.50 ± 0.05	8.00 ± 0.10	4.00 ± 0.10	2.00 ± 0.05	0.25 ± 0.02	12.00 + 0.30 - 0.10	17.80 ± 0.30
	(inch)	0.069 ± 0.004	0.217 ± 0.002	0.315 ± 0.004	0.157 ± 0.004	0.079 ± 0.002	0.010 ± 0.001	0.472 + 0.012 - 0.004	0.701 ± 0.012

Marking Code

Part Number	Marking Code
ACMS40N04V8-HF	080N04

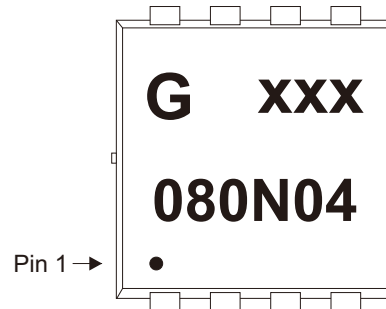

XXX = Control code

Suggested P.C.B. PAD Layout

SIZE	PDFN3x3-8L	
	(mm)	(inch)
A	0.42	0.017
B	0.70	0.028
C	0.65	0.026
D	2.25	0.089
E	2.37	0.093
F	0.42	0.017
G	0.23	0.009
H	1.85	0.073
I	3.70	0.146

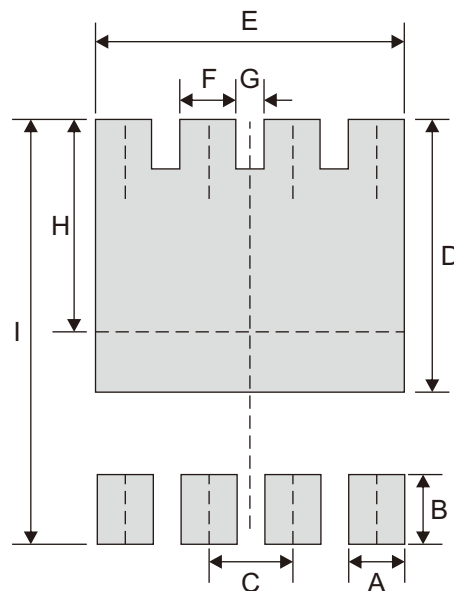

Standard Packaging

Case Type	REEL PACK	
	REEL (pcs)	Reel Size (inch)
PDFN3x3-8L	5,000	13